



AIR COMPRESSOR/GENERATOR
OPERATOR'S MANUAL



CAUTION

**RISK OF INJURY! READ ENTIRE MANUAL BEFORE OPERATING!
THIS MANUAL IS AN IMPORTANT PART OF THE AIR COMPRESSOR/GENERATOR
AND MUST REMAIN WITH THIS UNIT!**

Introduction

THANK YOU for purchasing a Mi-T-M product.

READ THIS MANUAL carefully to learn how to operate and service your machine correctly. Failure to do so could result in personal injury or equipment damage. This manual and safety signs on your machine may also be available in other languages. (See your dealer to order.)

THIS MANUAL SHOULD BE CONSIDERED a permanent part of your machine and should remain with the machine when you sell it.

MEASUREMENTS in this manual are given in both metric and customary U.S. unit equivalents. Use only correct replacement parts and fasteners. Metric and inch fasteners may require a specific metric or inch wrench.

RIGHT HAND AND LEFT HAND sides are determined by facing the motor end of the machine.

The SERIAL NUMBER is located in the Specification or Identification Numbers section. Accurately record all the numbers to help in tracing the machine should it be stolen. Your dealer also needs these numbers when you order parts. File the identification numbers in a secure place off the machine.

WARRANTY is provided from your dealer for customers who operate and maintain their equipment as described in this manual. The warranty is explained on the warranty certificate shown in this manual.

This warranty provides you the assurance that your dealer will back products where defects appear within the warranty period. Should the equipment be abused, or modified to change its performance beyond the original factory specifications, the warranty will become void.

WARNING

 **WARNING:** This product can expose you to chemicals including Lead, which is known to the State of California to cause cancer and birth defects or other reproductive harm. For more information go to www.P65Warnings.ca.gov

WARNING

 **WARNING:** This product can expose you to chemicals including carbon monoxide, which is known to the State of California to cause birth defects or other reproductive harm. For more information go to www.P65Warnings.ca.gov

Contents

	Page
Safety	5
Safety Signs	14
Controls	15
Installation	16
Operation	20
Troubleshooting	23
Maintenance	25
Storage	29
Specifications	30
Warranty	31

All information, illustrations and specifications in this manual are based on the latest information available at the time of publication. The right is reserved to make changes at any time without notice.

Contents

Safety

RECOGNIZE SAFETY INFORMATION

This is the safety alert symbol. When you see this symbol on your machine or in this manual, be alert to the potential for personal injury.

Follow recommended precautions and safe operating practices.



UNDERSTAND SIGNAL WORDS

A signal word--DANGER, WARNING or CAUTION--is used with the safety-alert symbol. DANGER identifies the most serious hazards.

DANGER or WARNING safety signs are located near specific hazards. General precautions are listed on CAUTION safety signs. CAUTION also calls attention to safety messages in this manual.



FOLLOW SAFETY INSTRUCTIONS

Carefully read all safety messages in this manual and safety signs on your machine. Keep safety signs in good condition. Replace missing or damaged safety signs. Be sure new equipment components and repair parts include the current safety signs. Replacement safety signs are available from your dealer.

Learn how to operate the machine and how to use controls properly. Do not let anyone operate without instruction.

Keep your machine in proper working condition. Unauthorized modifications to the machine may impair the function and/or safety and affect machine life.

If you do not understand any part of this manual and need assistance, contact your dealer.





CARBON MONOXIDE - POISONOUS GAS

Use unit outdoors, away from open windows, vents, or doors.

Unit exhaust contains carbon monoxide - a poisonous gas that can kill you. You **CAN NOT** smell or see this gas.

Never use the unit in enclosed or partially-enclosed spaces. The unit can produce high levels of carbon monoxide very quickly. When you use this unit, remember that you cannot smell or see carbon monoxide. Even if you can't smell exhaust fumes, you may still be exposed to carbon monoxide.

If you start to feel sick, dizzy, or weak while using the unit, get to fresh air **RIGHT AWAY**. **DO NOT DELAY**. The carbon monoxide from the unit can rapidly lead to full incapacitation and death.

If you experience serious symptoms, get medical attention immediately. Inform medical staff that carbon monoxide poisoning is suspected. If you experienced symptoms while indoors, have someone call the fire department to determine when it is safe to re-enter the building.

NEVER operate the unit in an explosive atmosphere, near combustible materials or where ventilation is not sufficient to carry away exhaust fumes. **Exhaust fumes can cause serious injury or death.**

NEVER use the unit indoors, including in homes, garages, basements, crawl spaces, and other enclosed or partially-enclosed areas, even with ventilation. Opening doors and windows or using fans will not prevent carbon monoxide build-up in the home.

Follow the instructions that come with your unit. Locate the unit outdoors and away from doors, windows, and vents that could allow the carbon monoxide gas to come indoors.

ONLY run unit outdoors and away from air intakes.

NEVER run unit inside homes, garages, sheds, or other semi-enclosed spaces. These spaces can trap poisonous gases **EVEN** IF you run a fan or open doors and windows.

If you start to feel sick, dizzy, or weak while using the unit, shut it off and get fresh air **RIGHT AWAY**. See a doctor. You may have carbon monoxide poisoning.

Install battery-operated carbon monoxide alarms or plug-in carbon monoxide alarms with battery back-up in your home, according to the manufacturer's installation instructions. The carbon monoxide alarms should be certified to the requirements of the latest safety standards for carbon monoxide alarms. (UL 2034, IAS 6-96, or CSA 6.19.01).

Test your carbon monoxide alarm frequently and replace dead batteries.

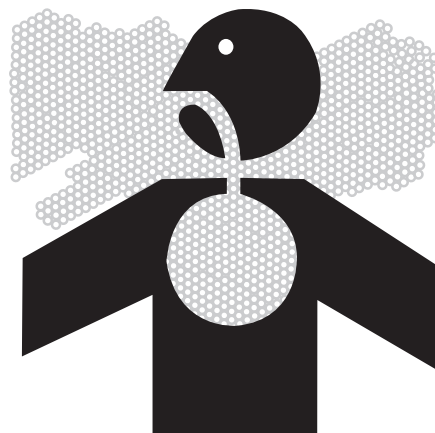

DANGER / PELIGRO

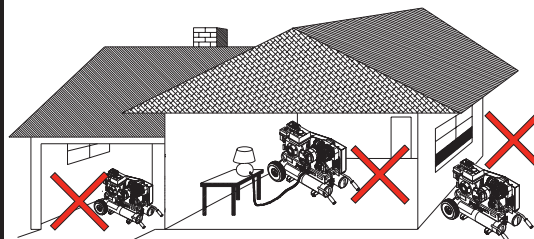

• DO NOT USE INDOORS OR OUTSIDE OPEN WINDOWS FUMES CAN KILL YOU!
• NE PAS UTILISER À L'INTÉRIEUR OU À L'EXTÉRIEUR DES FENÊTRES OUVERTES. LES VAPEURS DE GAZ PEUVENT VOUS TUER!
• ¡NO USE ADENTRO O AFUERA DE VENTANAS ABIERTAS LOS GASES PUEDEN MATARLE!

34-1563-E/F/S-062104-ENG.



SAFETY WARNING WHEN REFUELING

Injury or death may occur as a result of improper fueling. Do not smoke while filling engine fuel tank.

Always refuel slowly to avoid the possibility of spilled fuel which may cause a risk of fire.

Gasoline is extremely flammable and its vapors can explode if ignited.

Observe all safety regulations for the safe handling of fuel. Handle fuel in safety containers. If the container does not have a spout, use a funnel.

Do not overfill the fuel tank, leave room for the fuel to expand.

Fill the tank only on an area of bare ground. While fueling the tank, keep heat, sparks and open flame away. Carefully clean up any spilled fuel before starting engine.

Always fill fuel tank in an area with plenty of ventilation to avoid inhaling dangerous fumes.

NEVER store fuel for your unit in the home. Gasoline, propane, kerosene, and other flammable liquids should be stored outside of living areas in properly-labeled, non-glass safety containers. Do not store them near a fuel-burning appliance, such as a natural gas water heater in a garage. If the fuel is spilled or the container is not sealed properly, invisible vapors from the fuel can travel along the ground and can be ignited by the appliance's pilot light or by arcs from electric switches in the appliance.

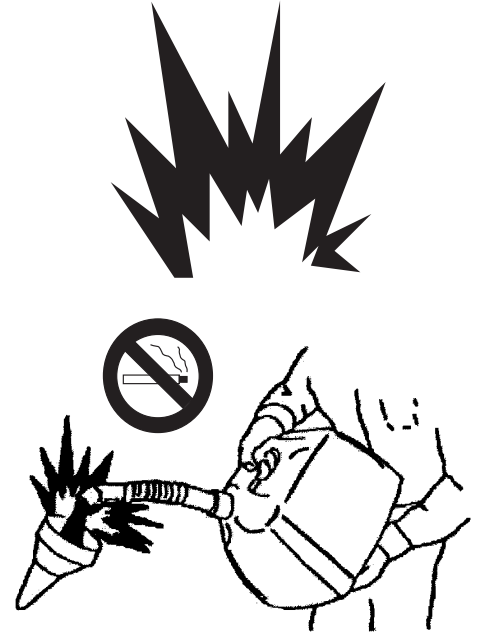



ELECTRICAL HAZARDS

This product must be grounded. If it should malfunction or breakdown, grounding provides a path of least resistance for electric current to reduce the risk of electric shock.



DANGER - IMPROPER CONNECTION OF THE EQUIPMENT-GROUNDING CONDUCTOR CAN RESULT IN A RISK OF ELECTROCUTION. CHECK WITH A QUALIFIED ELECTRICIAN OR SERVICE PERSON IF YOU ARE IN DOUBT AS TO WHETHER THE UNIT IS PROPERLY GROUNDED.

This unit is equipped with a grounding terminal for your protection. Always complete the ground path from the unit to an external ground source as instructed in the section labeled "Grounding Instructions" in the Preparation section of this manual.

The unit is a potential source of electrical shock if not kept dry. Keep the unit dry and do not use in rain or wet conditions. To protect from moisture, operate it on a dry surface under an open, canopy-like structure. Dry your hands if wet before touching the unit.

Plug appliances directly into the unit. Or, use a heavy duty, outdoor-rated extension cord that is rated (in watts or amps) at least equal to the sum of the connected appliance loads. Check that the entire cord is free of cuts or tears and that the plug has all three prongs, especially a grounding pin.

NEVER try to power the house wiring by plugging the unit into a wall outlet, a practice known as "back feeding". This is an extremely dangerous practice that presents an electrocution risk to utility workers and neighbors served by the same utility transformer. It also bypasses some of the built-in household circuit protection devices.

If you must connect the unit to the house wiring to power appliances, have a qualified electrician install the appropriate equipment in accordance with local electrical codes. Or, check with your utility company to see if it can install an appropriate power transfer switch.

For power outages, permanently installed stationary units are better suited for providing backup power to the home. Even a properly connected portable unit can become overloaded. This may result in overheating or stressing the unit components, possibly leading to a unit failure.





RISK OF FIRE OR EXPLOSION

Serious injury or death may occur from normal sparks in the engine ignition system or engine exhaust/muffler. Always operate the unit in a well ventilated area free of flammable vapors, combustible dust, gases or other combustible materials.

DO NOT SMOKE if spraying flammable material. Locate the unit at least 20 feet away from the spray area. (An additional hose may be required.)

Never fill the engine fuel tank while the engine is running or hot. Allow the engine to cool two minutes before refueling. Do not refuel indoors or in a poorly ventilated area.

Do not operate the unit if gasoline is spilled. Wipe the unit clean and move it away from the spill. Avoid creating any ignition until the gasoline has evaporated.

Do not store the unit near an open flame or any equipment such as a stove, furnace, water heater, etc. which utilizes a pilot light or sparking device.

A spark arrester must be added to the muffler of this engine if it is to be used on any forest covered, brush covered or grass covered unimproved land. The arrester must be maintained in effective working order by the operator.

Serious injury may occur if any of the unit's ventilation openings are restricted, causing the unit to overheat and start a fire. Never place objects against or on top of the unit. Operate the unit at least 12 inches away from any wall or obstruction that would restrict proper ventilation.

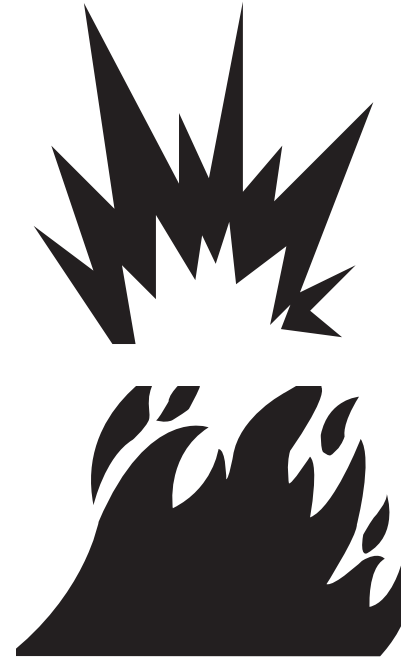

RISK OF BURSTING

Serious injury or death may occur from an air tank explosion if air tanks are not properly maintained. Drain air tank daily or after each use to prevent moisture buildup in the air tank.

If air tank develops a leak, replace the air tank immediately. Never repair, weld or make modifications to the air tank or its attachments. Use only genuine manufacturer repair parts for your unit. NEVER make adjustments to the factory set pressures.

Serious injury may occur from the unit malfunction or exploding accessories if incorrect system components, attachments or accessories are used. Never exceed manufacturers maximum allowable pressure rating of attachments.

Because of extreme heat, do not use plastic pipe or lead tin soldered joints for a discharge line.

Never use the unit to inflate small, low pressure objects such as toys.





RISK OF BREATHING

Serious injury or death could occur from inhaling compressed air. The air stream may contain carbon monoxide, toxic vapors or solid particles. Never inhale air from the unit either directly or from a breathing device connected to the unit.

Serious injury or death may occur from inhaling engine exhaust. This unit was designed for outdoor use. Never operate this unit in an enclosed area. Always make certain there is adequate ventilation (fresh outside air) for breathing and combustion. This will prevent the buildup of dangerous carbon monoxide gases. Beware of poorly ventilated areas, or areas with inadequate exhaust fans.

Sprayed materials such as paint, solvents, paint remover, insecticides, weed killers, etc. contain harmful vapors and poisons. Operate the unit only in a well ventilated area. Follow all safety instructions provided with the materials you are spraying. Use of a respirator may be required when working with some materials.

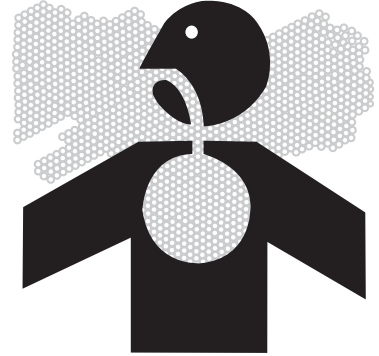

RISK OF BURNS

Serious injury could occur from touching exposed metal parts. These areas can remain hot for some time after the unit is shutdown. Never allow any part of your body or other materials to make contact with any exposed metal parts on the unit.

Never allow any part of your body to contact the engine muffler, compressor head or adjacent areas.





RISK OF FLYING OBJECTS

Soft tissue damage can occur from the compressed air stream. Always wear safety glasses to shield the eyes from flying debris.

Never point the air stream at any part of your body, anyone else or animals.

Never leave pressurized air in the unit. Shut off the unit and relieve pressure when storing or attempting maintenance.

Serious injury can occur from loose debris being propelled at a high speed from the compressed air stream. Always maintain a safe distance from people and animals while operating the unit.

Do not move the unit while air tank is under pressure. Do not attempt to move the unit by pulling on the hose.



RISK FROM MOVING PARTS

Risk of bodily injury from moving parts. Before performing maintenance, always turn off the unit. Bleed pressure from the air hose and disconnect spark plug wire (for gasoline engines), or remove the negative wire from the battery post (for Diesel engines) to prevent engine from starting unexpectedly. All repairs to the unit should be made by an Authorized Service person.

Do not operate without protective covers/guards. Always turn off the unit before removing any guard. Replace damaged covers/guards before using the unit.





IMPORTANT SAFETY INSTRUCTIONS

WARNING: To reduce the risk of injury, read this operator's manual completely before using. When using this product, the following basic precautions should always be followed:

1. Risk from Negligence: Risk of injury from negligent use. Never allow children or adolescents to operate this unit! Stay alert—watch what you are doing. Do not operate the unit when fatigued or under the influence of alcohol or drugs. Know how to stop the unit. Be thoroughly familiar with controls.
2. Risk of Unit Damage: Risk of major repair. Do not operate the unit without an air filter. Do not operate the unit in a corrosive environment. Always operate the unit in a stable, secure position to prevent the unit from falling. Follow all maintenance instructions listed in this manual.
3. When starting the unit, using recoil starter grip, be sure that nothing is in a position to be hit by the operator's hand or arm. Be sure the switch on electrical power tools is in the "OFF" position before plugging them into the unit.
4. Do not operate the unit or any electrical tool in any area where water or similar materials constitute an electrical hazard to the operator. Do not operate on wet surfaces, in rain or in snow.
5. Always be sure that the unit is on secure footing so that it cannot slide or shift around, endangering workers.
6. Avoid contacting the hot exhaust manifold, muffler or cylinder(s).
7. Keep clear of all rotating parts.
8. Unless the tool or appliance is double insulated, it must be grounded through a properly grounded receptacle. Tools and appliances which have 3 prong plugs must be plugged into extension cords and electrical receptacles with 3 holes. Before operating any electrical item, be sure it is in good repair.
9. Beware of using this equipment in confined spaces. Confined spaces, without sufficient fresh air ventilation, can contain dangerous gases. Running gasoline engines in such environments can lead to deadly explosions and/or asphyxiation.
10. Use extreme caution when lifting this unit. This unit is heavy so proper lifting techniques should be used.



SAVE THESE INSTRUCTIONS



WEAR PROTECTIVE CLOTHING

Wear close fitting clothing and safety equipment appropriate to the job.

Wear a suitable hearing protective device such as earmuffs or earplugs to protect against objectionable or uncomfortable loud noises.

Operating equipment safely requires the full attention of the operator. Do not wear radio or music headphones while operating machine.



PREPARE FOR EMERGENCIES

Keep a first aid kit and fire extinguisher handy.

Keep emergency numbers for doctors, ambulance service, hospital and fire department near your telephone.

Be prepared if a fire starts.

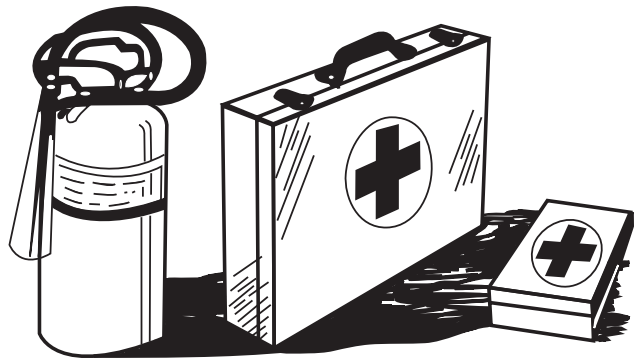

INSPECT UNIT

Be sure all covers, guards and shields are tight and in place.

Locate all operating controls and safety labels.

Inspect power cord for damage before using. There is a hazard of electrical shock from crushing, cutting or heat damage.

SERVICE UNIT SAFELY

Before servicing the unit, disconnect all equipment and battery (if equipped) and allow unit to cool down.

Service unit in a clean dry flat area.



SAFETY SIGNS

MAINTENANCE INSTRUCTIONS INSTRUCCIONES DE MANTENIMIENTO

REFER TO INSTRUCTION MANUAL FOR DETAILED INSTRUCTIONS.

If unit is operated in an excessively dirty or dusty area, increase the frequency of all checks.

Daily:

- Check for proper oil level(s) and oil leaks.
- Check engine air filter. (If applicable)
- Drain moisture from tank(s) daily or after each use.
- Ensure all safety guards are correctly & securely attached.

Weekly:

- Clean the cooling surfaces of the compressor.
- Inspect air intake filter.
- Check safety valves by pulling on rings.

Monthly:

- Check system for air leaks.
- Check belt tension.

Every 200 hours:

- Change pump oil.
- Replace air filter.

REFER TO ENGINE MANUAL FOR RECOMMENDED ENGINE MAINTENANCE.

LEA LAS INSTRUCCIONES PARA INSTRUCCIONES PARTICULARES.

Si la unidad está usada en un lugar bien sucio o de polvo, haga la frecuencia de los exámenes más.

Cada día:

- Inspeccione para el nivel de aceite y vias de aceite.
- Inspeccione el filtro de aire (si hay).
- Drene la humedad de los tanques cada día o después de usar.
- Asegúrese que las guardas de seguridad son acompañados segundamente y correctamente.

Cada semana:

- Limpie las superficies enfriés del compresor.
- Inspeccione el filtro del aire.
- Inspeccione las válvulas con tirando los anillos.

Cada mes:

- Inspeccione la sistema para vias.
- Inspeccione la tensión de la correa.

Cada doscientos horas:

- Cambie el aceite de la bomba.
- Reemplace fitlo del aire.

LEA USTED EL MANUAL DEL MOTOR PARA EL MANTENIMIENTO RECOMENDADO DEL MOTOR.

34-1285
Location: Baseplate

WARNING/ADVERTENCIA

RISK OF BURNS
Muffler and adjacent areas may exceed 150°F.

RIESGO DE QUEMAR
El amortiguador y las areas adyacentes pueden Tener temperaturas por arriba de 65°C.

34-0598

Location: Engine

CAUTION/PRECAUCIÓN

RISK OF FIRE
Do not add fuel when product is operating. Allow engine to cool for two (2) minutes before refueling.

RIESGO DE FUEGE
No ponga combustible cuando el producto este en operacion. Permita que el motor se enfrie por 2 minutos antes de reablastecer de combustible.

34-0599

Location: Engine

WARNING

READ ENTIRE INSTRUCTION MANUAL BEFORE OPERATING AIR COMPRESSOR!

RISK OF FIRE OR EXPLOSION!

- Do not spray flammable liquid in a confined area. Spray area must be well ventilated. Do not smoke while spraying or spray where spark or flame is present. Keep compressors as far from spraying area as possible.
- When a combustible liquid is sprayed there may be danger of fire or explosion, especially in a closed area.
- Arcing parts. Keep the unit at least 6m away from explosive vapors.
- Engine creates sparks. Do not operate in flammable environment. Follow all instructions and warnings supplied with material to be sprayed.
- Do not smoke while filling engine fuel tank. Follow all fueling instructions in operator's manual.
- Air tanks may explode if not properly maintained. To prevent weakening of tanks caused by corrosion, drain tanks after each use.
- The equipment incorporates parts, such as snap switches, receptacles, produce arcs or sparks and, therefore, when located in a garage, it should be in a room or enclosure provided for the purpose, or should be 16 inches (457mm) or more above the floor.

RISK OF ASPHYXIATION!

- Never use compressed air for breathing or respiration!
- Gasoline engines produce carbon monoxide, a poisonous, odorless gas which may cause death! Do not start or operate compressor in an enclosed area. Area must be well ventilated.

RISK OF SEVERE INJURY!

- Before servicing gasoline unit, disconnect spark plug wire to prevent unit from starting unexpectedly.
- Wear safety glasses/face shields at all times.
- Never operate with beltguard removed. If guard becomes damaged, repair or replace before operating.
- Do not remove any air line or tank connections before relieving all pressure in the tank(s).
- Loose debris can be propelled at high speeds. Never direct air stream towards yourself or others.

RISK OF BURNS!

- Do not touch compressor head, discharge lines or engine components. Cool before servicing.

RISK OF DAMAGING COMPRESSOR AND CAUSING INJURY!

- Do not operate at pressure or speed in excess of manufacturer's recommendations.
- Do not operate with components rated less than the pressure marked on the nameplate.
- Follow required maintenance procedures and intervals listed in the operator's manual. Service should be performed only by qualified personnel. Compressor requires good ventilation to operate properly. Use only factory replacement parts.

FAILURE TO COMPLY WITH THESE WARNINGS WILL RESULT IN PERSONAL INJURY. DO NOT REMOVE THIS LABEL!

ADVERTENCIA

LEA USTED EL MANUAL DE INSTRUCCIONES ANTES DE USAR EL COMPRESOR DEL AIRE!

RIESGO DE INCENDIO O EXPLOSION!

- No rocíe el líquido inflamable en una área confinada la área para rociar tiene que ser bien ventilado. No fume cuando está rociando ni vocie donde hay incendio o centella. Ponga los compresores lejos de la área de voocar si es posible.
- Cuando un líquido inflamable está rociado hay posible peligro de incendio o explosión, especialmente en un lugar cerrado.
- Partes de arco. Ponga la unidad nunca de 6m lejos de las vapores explosivos.
- El motor se causan las centellas. No use en un lugar inflamable. Siga usted las instrucciones y advertencias con el material para rociar.
- No fume cuando está llenando el tanque de combustible siga todas las instrucciones de combustible en el manual del operador.
- Los tanques del aire puede explotar si no se mantenga bien. Para evitar la debilitación de los tanques del corrosión, drene los tanques cada uso.
- Este equipo tiene los partes con interruptor de resacas, receptáculos, se producen o centellas y por eso, cuando está en un espacio debe estar en un cuarto o un encierroamiento por está, o debe estar 16 pulgadas (457 mm) o encima del suelo.

RIESGO DE LESIONES GRAVES!

- Antes de mantener la unidad gasolina, desconecte el hilo de la telegrafista para evitar la unidad a arrancar inesperadamente.

RIESGO DE QUEMADURAS!

- No toque la cabeza del compresor, líneas del descargo o partes del motor. Permita que se enfria antes del servicio.

RIESGO DE ASFIXIA!

- Nunca se use el aire del compresor para respirar o respiración!
- El motor produce carbon monóxido un vapor tóxico un dor que se puede causar morir. No use a arranca un lugar encerrado. El área debe ser bien ventilado.

RIESGO DE DAÑO DEL COMPRESOR O LESIONES!

- Lleve gafas de seguridad o blindaje todo el tiempo.
- Nunca opere en cinturón de protección. Si el cinturón está dañado repare o reemplaza antes de usarlo.
- Nunca toque cualquier línea del aire o conexiones del tanque antes de alimando del aire en los tanques.
- No dirija el rociado de alta presión hacia ninguna persona ni hacia usted mismo. Escrombras se vuelan rápido.
- No opere a una presión o una velocidad más que se recomienda en el manual.
- No opere con partes clasifican menos de la presión que ha escrito en el plato de nombre.
- Siga los procedimientos de mantenimiento y intervalos que se dicen en el manual de operador.
- Servicio debe hacer solamente por las personas calificadas. Para funcionar correctamente, necesita un lugar bien ventilado. Use solamente partes para reemplazar de la fábrica.

SI NO SIGA USTED ESTAS ADVERTENCIAS PUEDE CAUSAR LESIONES. NO SAQUE LA ETIQUETA!

34-1615
Location: Baseplate

WARNING/ADVERTENCIA

Do not operate unit without beltguard in place.

No opere la unidad sin todas la cubierta correa en su sitio.

34-0826

Location: Beltguard

WARNING/ADVERTENCIA

RISK OF BURNS
Beware of Hot Surfaces. Allow unit to cool before servicing.

RIESGO DE QUEMADURA
Tenga ud cuidado de los superficies calientes. Permita que la unidad se enfrie antes de mantener.

34-1284

Location: Baseplate

34-1284
Location: Baseplate

DANGER Using a generator indoors CAN KILL YOU IN MINUTES. Generator exhaust contains carbon monoxide. This is a poison you cannot see or smell.

DANGER L'utilisation d'un groupe électrogène à l'intérieur PEUT VOUS TUER EN QUELQUES MINUTES. Le gaz d'échappement du groupe électrogène contient de l'oxyde de carbone. C'est un gaz toxique que l'on ne peut pas voir ou sentir.

PELIGRO Utilizando un generador adentro PUEDE MATARLE EN MINUTOS. El escape de generador contiene monóxido de carbono. Este es un gas tóxico que usted no puede ver ni puede oler.

NEVER use inside a home or garage, EVEN IF doors and windows are open. Only use OUTSIDE and far away from windows, doors, and vents.

Ne JAMAIS utiliser à l'intérieur d'une maison ou d'un garage, MÊME SI les portes et fenêtres s'ont ouvertes. N'utiliser qu'à l'EXTÉRIEUR et bien éloigné des fenêtres, portes, et conduits d'aération.

Nunca utilice dentro de un hogar ni el garaje, INCLUSO SI puertas y ventanas están abiertas. Solo utilice AFUERAS y lejos de ventanas abiertas, las puertas, y descargas.

34-1916/083012

34-1916

WARNING / ADVERTENCIA

RISK OF ELECTRICAL SHOCK OR ELECTROCUTION! A generator is a potential shock hazard which can result in serious injury or death. Generator must be kept dry. Do NOT operate unit with wet hands. Generator MUST be grounded before use. See operators manual for specific instructions. Do not use around water or expose to rain. Store indoors.

RIESGO DE CALAMBRE ELÉCTRICO O ELECTROCUCION! Un generador es un potencial riesgo de descarga que puede resultar en lesiones graves o muerte. Generadores tienen que mantener secos. No opere esta unidad con manos mojadas. Generador TIENE que sea conectado a tierra antes de uso. Vea manual de operador para instrucciones específicas. No use cerca agua ni tenga la unidad en la lluvia. Debe almacenarla dentro.

34-1616/081012

34-1616
Location: Generator

OPERATING INSTRUCTIONS FOR GASOLINE AIR COMPRESSORS INSTRUCCIONES DE OPERACION PARA COMPRESORES DEL AIRE GASOLINA

WARNING
AIR COMPRESSORS CAN CAUSE SERIOUS INJURY OR DEATH IF OPERATED IMPROPERLY. BEFORE OPERATING THIS COMPRESSOR, READ AND UNDERSTAND THE ENTIRE OPERATOR'S MANUAL AND FOLLOW ALL SAFETY PRECAUTIONS.

ADVERTENCIA
LOS COMPRESORES DEL AIRE PUEDEN CAUSAR LESIONES GRAVES LA MUERTE SI SE USE INCORRECTAMENTE. ANTES DE USAR EL COMPRESOR, LEA Y ENTENDA TODAS LAS INSTRUCCIONES EN EL MANUAL Y OBSERVE LAS PRECAUCIONES DE SEGURIDAD.

WARNING: Cancer and Reproductive Harm — www.P65warnings.ca.gov/

1. Flip the toggle on top of the pilot valve to the upright position. This provides a loadless start.
2. Start the engine. (Refer to Engine Manual accompanying this unit.)
3. When engine has run for 1-2 minutes, flip toggle back to original position.
4. Stop the engine. (Refer to Engine Manual accompanying this unit.)
5. Drain air from the tanks by releasing air with an attached air tool or by pulling on the safety relief valve rings.
6. Once pressure in the tanks register under 10 pounds, open the drain valve under each tank to drain any moisture.

ADVERTENCIA: Peligro de cáncer y daño reproductivo — www.P65warnings.ca.gov/

1. Eche la palanca accodada encima de la válvula piloto a la posición vertical. Con este hay un arranque sin carga. El compresor va a descargarse y premiar el motor a arranca fácilmente.
2. Arranque el motor. (Lea el manual del motor que está acompañado está unidad)
3. Cuando la unidad funciona para 1-2 minutos, mueva la palanca accodada a la posición original.
4. Cierre el motor. (Lea el manual que está acompañado está unidad)
5. Drene los tanques del aire con un instrumento acompañado del aire o tire los anillos de la válvula segura.
6. Cuando la presión en los tanques es menos de diez libras, abra la válvula debajo de cada tanque para des agua cualquier humedad.

34-1286/071316

34-1286
Location: Beltguard

Controls

CONTROLS (8 GALLON)

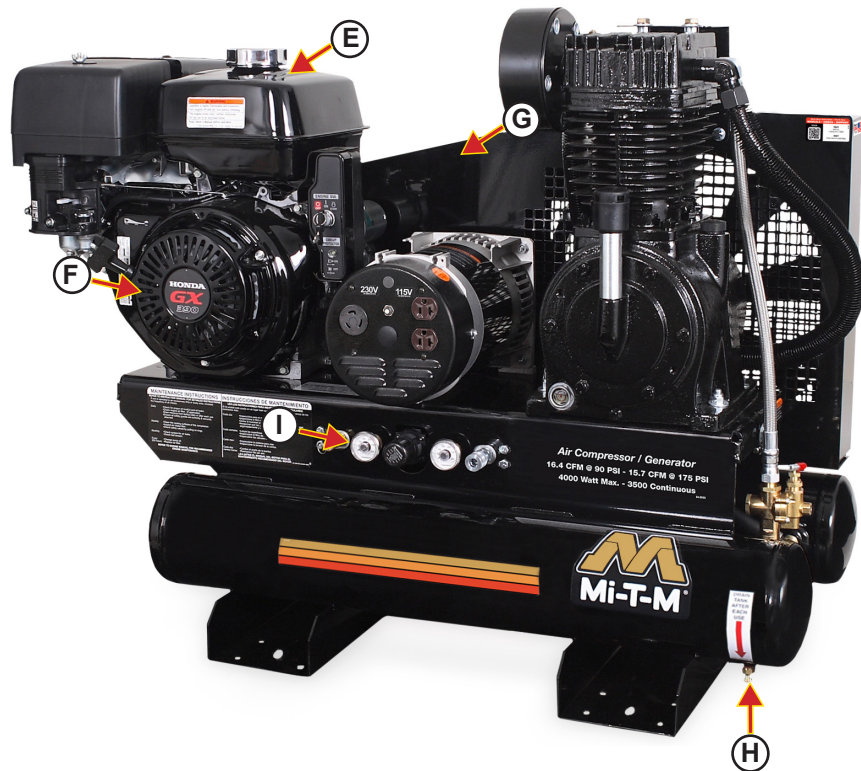

A -- Generator
B -- Pump
C -- Oil Sight Glass

D -- Handle
E -- Fuel Tank
F -- Engine

G -- Beltguard
H -- Tank Drain Valve
I -- Pressure Gauge

Controls

CONTROLS (30 GALLON)

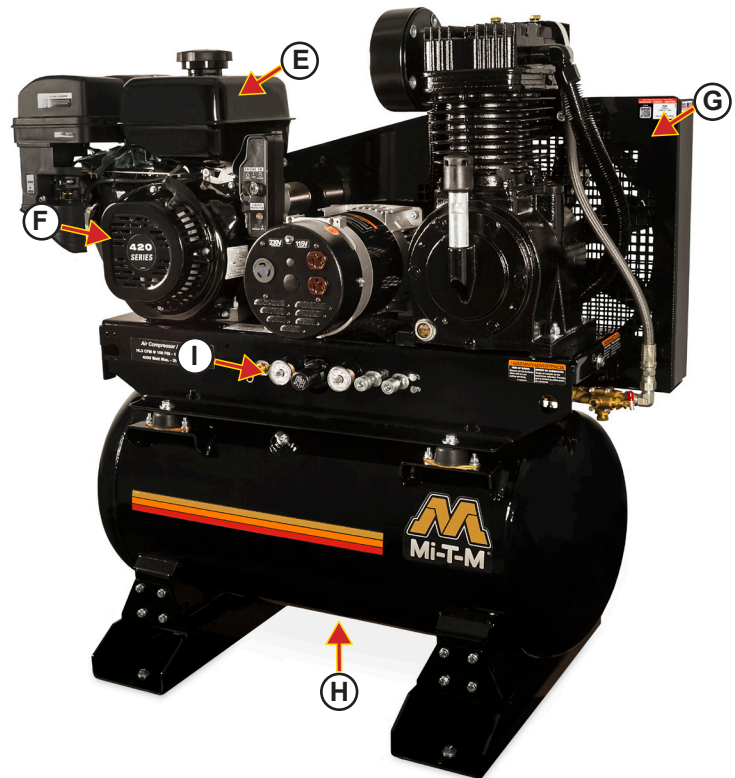

A -- Generator
B -- Pump
C -- Oil Sight Glass

D -- Handle
E -- Fuel Tank
F -- Engine

G -- Beltguard
H -- Tank Drain Valve
I -- Pressure Gauge

Installation

INSTALLATION

Read safety warnings before setting-up the unit.

Ensure the oil level in the unit's pump is adequate. If low, add SAE-30W non-detergent oil.

LOCATION:

In order to avoid damaging the unit, do not incline the unit transversely or longitudinally more than 10°.



WARNING: RISK OF ASPHYXIATION! DO NOT OPERATE IN AN ENCLOSED AREA. USE THIS PRODUCT ONLY IN WELL VENTILATED AREAS! THE EXHAUST FROM THE ENGINE CONTAINS CARBON MONOXIDE, A POISONOUS, ODORLESS AND INVISIBLE GAS. BREATHING THE GAS CAN CAUSE SERIOUS INJURY, ILLNESS AND POSSIBLE DEATH.



WARNING: RISK OF EXPLOSION OR FIRE CAUSING SERIOUS INJURY OR DEATH! DO NOT ALLOW THE ENGINE OR MUFFLER TO COME IN CONTACT WITH FLAMMABLE VAPORS, COMBUSTIBLE DUST, GASES OR OTHER COMBUSTIBLE MATERIALS. A SPARK MAY CAUSE A FIRE.

WHEN USING THE UNIT FOR SPRAY PAINTING, PLACE THE UNIT AS FAR AWAY FROM THE WORK AREA AS POSSIBLE, USING EXTRA AIR HOSES IF NEEDED.

Place unit at least 12 inches away from obstacles that may prevent proper ventilation. Do not place unit in an area:

- where there is evidence of oil or gas leaks.
- where flammable gas vapors or materials may be present.
- where air temperatures fall below 32°F or exceed 104°F.
- where extremely dirty air or water could be drawn into the unit.

SERVICE TRUCK INSTALLATION:

Installations may vary. Mounting should be done to a rigid frame member. Installer is responsible for securing the equipment in a safe manner.

8 Gallon Units:

Recommended Hardware: 854-0093 (Dome Isolators)

30 Gallon Units:

Optional Hardware: 854-0093 (Dome Isolators)

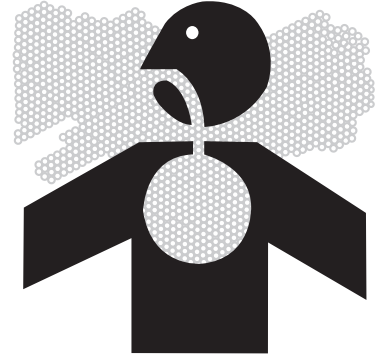

GROUNDING INSTRUCTIONS

This product must be grounded. If it should malfunction or breakdown, grounding provides a path of least resistance for electric current to reduce the risk of electric shock.



DANGER: IMPROPER CONNECTION OF THE EQUIPMENT - GROUNDING CONDUCTOR CAN RESULT IN A RISK OF ELECTROCUTION. CHECK WITH A QUALIFIED ELECTRICIAN OR SERVICE PERSON IF YOU ARE IN DOUBT AS TO WHETHER THE UNIT IS PROPERLY GROUNDED.

The screw and ground terminal on the frame must always be used to connect the unit to a suitable ground source. The ground path should be made with #8 size wire. Connect the terminal of the ground wire between the star washers and screw then tighten the screw fully. Connect the other end of the wire securely to a suitable ground source.

The National Electric Code contains several practical ways in which to establish a good ground source. Examples given below illustrate a few of the ways in which a good ground source may be established.

A metal underground water pipe in direct contact with the earth for at least 10 feet can be used as a grounding source. If a pipe is unavailable, an 8 foot length of pipe or rod may be used as the ground source. The pipe should be 3/4 inch trade size or larger and the outer surface must be noncorrosive. If a steel or iron rod is used it should be at least 5/8 inch diameter and if a nonferrous rod is used it should be at least 1/2 inch diameter and be listed as material for grounding. Drive the rod or pipe to a depth of 8 feet. If a rock bottom is encountered less than 4 feet down, bury the rod or pipe in a trench. All electrical tools and appliances operated from this unit, must be properly grounded by use of a third wire or be "Double Insulated".

It is recommended to:

1. Use electrical devices with 3 prong power cords.
2. Use an extension cord with a 3 hole receptacle and a 3 prong plug at the opposite ends to ensure continuity of the ground protection from the unit to appliance.

Mi-T-M strongly recommend that all applicable federal, state and local regulations relating to grounding specifications be checked and followed.

LINE TRANSFER SWITCH:

If this unit is used for standby service, it must have a transfer switch between the utility power service and the unit. The transfer switch not only prevents the utility power from feeding into the unit, but also prevents the unit from feeding out into the utility company's lines. This is intended to protect the serviceman who may be working on a damaged line.

THIS INSTALLATION MUST BE DONE BY A LICENSED ELECTRICIAN AND ALL LOCAL CODES MUST BE FOLLOWED.



ENGINE

Review "Risk of Fire or Explosion" before fueling. Read the engine manual accompanying this unit for correct engine start-up maintenance procedures. Read and understand the safety labels located on the unit.



WARNING: RISK OF EXPLOSION OR FIRE CAUSING SERIOUS INJURY OR DEATH! DO NOT SMOKE WHILE FUELING!

DO NOT FILL FUEL TANK WHILE THE UNIT IS RUNNING OR HOT. ALLOW THE UNIT AND ENGINE TO COOL DOWN FOR TWO MINUTES BEFORE REFUELING.

DO NOT FILL FUEL TANK TO POINT OF OVERFLOWING. ALLOW APPROXIMATELY 1/4" OF TANK SPACE FOR FUEL EXPANSION.

DO NOT PLACE UNIT IN AN AREA WHERE FLAMMABLE GAS VAPORS MAY BE PRESENT. A SPARK COULD CAUSE AN EXPLOSION OR FIRE.

ALWAYS STORE FUEL AWAY FROM THE UNIT WHILE IT IS RUNNING OR HOT.



WARNING: RISK OF EXPLOSION OR FIRE CAUSING SERIOUS INJURY OR DEATH DO NOT ALLOW THE ENGINE OR MUFFLER TO COME IN CONTACT WITH FLAMMABLE VAPORS, COMBUSTIBLE DUST, GASES OR OTHER COMBUSTIBLE MATERIALS. A SPARK MAY CAUSE A FIRE.

WHEN USING THE UNIT FOR SPRAY PAINTING, PLACE THE UNIT AS FAR AWAY FROM THE WORK AREA AS POSSIBLE, USING EXTRA AIR HOSES IF NEEDED.

A minimum of 86 octane fuel is recommended for use with this air compressor. Do not mix oil with gasoline.

Use of clean, fresh, lead free gasoline is recommended. Leaded gasoline may be used if lead free is not available. Do not use gasoline containing methanol or alcohol.

For Diesel units use low or ultra-low sulfur fuels only. Read engine manual for recommended fuels.

Refer to the engine manual for all necessary maintenance and adjustments.

HIGH ALTITUDE

At high altitude, the standard carburetor air/fuel mixture will be too rich. Performance will decrease, and fuel consumption will increase. A very rich mixture will also foul the spark plug on gasoline engines and cause hard starting. Operation at an altitude that differs from that at which this engine was certified, for extended periods of time, may increase emissions.

High altitude performance can be improved by specific modifications to the carburetor. If you always operate your unit at altitudes above 5,000 feet (1,500 meters), have your dealer perform this carburetor modification. This engine, when operated at high altitude with the carburetor modifications for high altitude use, will meet each emission standard throughout its useful life.

Even with carburetor modification, engine horsepower will decrease about 3.5% for each 1,000-foot (300-meter) increase in altitude. The effect of altitude on horsepower will be greater than this if no carburetor modification is made.

NOTE: *When the carburetor has been modified for high altitude operation, the air/fuel mixture will be too lean for low altitude use. Operation at altitudes below 5,000 feet (1,500 meters) with a modified carburetor may cause the engine to overheat and result in serious engine damage.*

For use at low altitudes, have your servicing dealer return the carburetor to original factory specifications.

Operation

OPERATION

Pre-Operation:

Check the engine oil level before starting. (See engine manual.) Fill the fuel tank according to the engine manual instruction.

Pump oil level should be checked before each use. Check the oil level indicator on the pump crankcase. Make certain the oil is in the center of the oil sight glass. If the level appears to be low, fill with SAE20 or 30 non-detergent pump oil.

Remove any moisture in the unit's air tank.



WARNING: NEVER ATTEMPT TO OPEN THE AIR TANK DRAIN VALVE WHEN MORE THAN 10 PSI OF AIR PRESSURE IS IN THE AIR TANK!

Remove excessive pressure with an air tool, then open the Air Tank Drain Valve in the bottom of the air tank. Close tightly when drained.

Make sure the Engine Switch is in the "OFF" position.

Make sure the Safety Relief Valve is working correctly.

Make sure all guards and covers are in place and securely mounted.

Start-up:

1. Read safety warnings before performing operation.

NOTE: *Unplug all equipment from the power receptacles before starting the unit.*

2. Flip the toggle on top of the Pilot Valve to the upright position. This provides a loadless start. The unit will unload and allow easier engine start-up.

3. Start the engine. (Refer to the Engine Manual accompanying this unit.)

4. When the engine has run for 1-2 minutes, flip toggle back to the original position.

5. Set pressure by adjusting the Pressure Regulator counterclockwise for less pressure and clockwise for more pressure. (Actual delivered pressure may vary from pump maximum pressure rating).

6. Make sure the unit is grounded. See Grounding Instructions.

7. Loads can now be applied to the unit.

NOTE: *This engine is equipped with a "Low Oil" shutdown system for engine protection. The engine stops when the oil level gets too low. The engine will not restart without adding oil. If you notice any unusual noise or vibration, stop the unit and refer to "Troubleshooting".*

Shutdown:

1. Remove all load by turning off electrical appliances and unplugging electric cords.

2. Move the Engine Switch to the "OFF" position. (Refer to the Engine Manual accompanying this unit.)

3. Drain air from the air tanks by releasing air with an attached air tool or by pulling on the Safety Relief Valve.

4. Once the Air Tank Pressure Gauge registers under 10 pounds, open the drain valve under each air tank to drain any moisture.

5. Allow the unit to cool down.

6. Wipe the unit clean and store in a safe, non-freezing, dry area.

OPERATION

CABLE SIZE:

Equipment damage can result from low voltage. Therefore, to prevent excessive voltage drop between the unit and the equipment, the cable should be of adequate gauge for the length used. The cable selection chart gives the maximum cable lengths for various gauges of wire which can adequately carry the loads shown.

CURRENT IN AMPS	LOAD IN WATTS		MAXIMUM CABLE LENGTH (FEET)				
	120 VOLTS	240 VOLTS	#8 WIRE	#10 WIRE	#12 WIRE	#14 WIRE	#16 WIRE
2.5	300	600		1000	600	375	250
5	600	1200		500	300	200	125
7.5	900	1800		350	200	125	100
10	1200	2400		250	150	100	50
15	1800	3600		150	100	65	
20	2400	4800	175	125	75	50	
25	3000	6000	150	100	60		
30	3600	7200	125	65			
40	4800	9600	90				

ELECTRIC MOTOR LOADS:

It is characteristic of common electric motors in normal operation to draw up to six times their running current while starting. This table may be used to estimate the watts required to start "CODE G" electric motors.



CAUTION: IF AN ELECTRIC MOTOR FAILS TO START OR REACH RUNNING SPEED, TURN OFF THE APPLIANCE OR TOOL IMMEDIATELY TO AVOID EQUIPMENT DAMAGE. ALWAYS CHECK THE REQUIREMENTS OF THE TOOL OR APPLIANCE BEING USED COMPARED TO THE RATED OUTPUT OF THE UNIT.

MOTOR (H.P.)	RUNNING WATTS	WATTS REQUIRED TO START MOTOR		
		REPULSION INDUCTION	CAPACITOR	SPLIT PHASE
1/8	275	600	850	1200
1/6	275	600	850	2050
1/4	400	850	1050	2400
1/3	450	975	1350	2700
1/2	600	1300	1800	3600
3/4	850	1900	2600	
1	1100	2500	3300	

Troubleshooting

Symptom	Problem	Solution
Engine will not start.	Various engine problems.	Refer to the engine manual accompanying your unit.
Noisy operation.	Loose engine pulley or pump flywheel.	Tighten pulley and or flywheel.
	Lack of oil in the pump.	Add correct amount of oil. Check for bearing damage.
	Carbon deposits on pistons or valves.	Remove cylinder head and inspect. Clean or replace.
	Bearing, piston or connecting rod failure.	STOP THE UNIT! Contact Mi-T-M customer service.
Pressure drop in air tank or rapid pressure loss when the unit is shut off.	Air leaks at connections.	Allow the unit to build pressure to the maximum allowed. Turn off and brush a soapy water solution onto all connections. Check connections for air bubbles. Tighten the connections where leaks are present.
	Air leak in air tank.	Air tank must be replaced. Do not attempt to repair air tank!
	Defective Pilot Valve.	Clean or replace.
Insufficient pressure at air tool or accessory.	Pressure Regulator not turned to high enough pressure or defective.	Adjust Pressure Regulator to proper setting or replace.
	Restricted air intake.	Clean or replace Air Intake Filter.
	Air leaks or restrictions.	Check for leaks and repair.
	Hose or hose connections are too small or long.	Replace with larger hose or connectors.
	Slipping belt.	Tighten or replace.
	The unit is not large enough for air requirement.	Check the accessory air requirement. If it is higher than the CFM or pressure supply to the air compressor, use a larger unit.
	Restriction in Pilot Valve.	Clean or replace.

Symptom	Problem	Solution
Unit has no output.	Circuit breakers tripped.	Reset circuit breakers.
	Inadequate cord sets or extension cords.	Check cord sets or extension cords capabilities.
Air leaks from Safety Relief Valve.	Possible defective Safety Relief Valves.	Operate Safety Relief Valve manually by pulling on ring. If it still leaks, it should be replaced.
	Excessive air tank pressure.	Clean, reset or replace Pilot Valve.
Air leaks at pump.	Defective gaskets.	Tighten bolts on compressor head to proper torque or replace gaskets.
Air blowing from Air Intake Filter.	Defective inlet (reed) valve.	Contact your Mi-T-M Customer Service Center.
Moisture in discharge air.	Condensation in air tank caused by high level of atmospheric humidity or the unit is not run long enough.	Run the unit a minimum of one hour to prevent condensation buildup. Drain air tank more often in humid weather and use an air line filter.
Excessive oil consumption or oil in hose.	Restricted Air Intake Filter.	Clean or replace.
	The unit on unlevel surface.	Do not incline the unit more than 10° in any direction while running.
	Crankcase overfilled with oil.	Drain oil. Refill to proper level with SAE-30W non-detergent oil.
	Wrong viscosity.	Drain oil. Refill to proper level with SAE-30W non-detergent oil.
	Plugged crankcase breather.	Clean or replace.
	Oil leaks.	Tighten bolts on compressor to proper torque or replace gaskets.
	Worn piston rings or scored cylinder.	Contact your Mi-T-M Customer Service Center.
Oil has milky appearance.	Water in oil due to condensation.	Change oil and move air compressor to a less humid environment.
Unit has no output.	Inadequate cord sets or extension cords.	Check cord sets or extension cords capabilities in section Maintenance; Cable Size in this manual. Consult your Mi-T-M Customer Service Center.

Maintenance

MAINTENANCE

Read the instruction manual before performing maintenance.

Keep all air vents clear.

Keep the unit clean.

DO NOT spray with water.

Periodically check all fasteners and tighten, see the periodic maintenance chart.

The following procedures must be performed when stopping the unit for maintenance or service:

1. Turn off the unit.
2. Disconnect spark plug wire from engine. For electric start engines remove negative wire from battery post.
3. Open all drains.
4. Wait for the unit to cool before starting service.

Maintenance Chart:

To ensure satisfactory operation over an extended period of time, an engine requires normal maintenance at regular intervals. The Periodic Maintenance Chart below shows periodic inspection and maintenance items and suitable intervals. The bullet mark designates that the corresponding item should be performed at that interval.

NOTE: Some adjustments require the use of special tools or other equipment. An electronic tachometer will facilitate setting idle and running speeds.

Procedure	Daily	Weekly	Monthly	100 Hours	200 Hours	Before Storage
Check Pump Oil Level	x					
Check Engine Oil Level	x					
Oil Leak Inspection	x					
Check Engine Air Filter	x					
Drain Condensation in Air Tank (s)	x					
Inspect Guards/Covers	x					
Check for Unusual Noise/Vibration	x					
Check for Air Leaks	x					
Check cylinder and head fins for dust and dirt	x					
Check battery electrolyte level	x					
Check fuel lines (replace if necessary)	x					
Clean Exterior of Compressor		x				
Inspect Air Filter		x				
Inspect Belt			x			
Check Safety Relief Valve			x			
Change engine oil (**)				x		
Clean fuel filter				x		
Clean dust and dirt from cylinder and cylinder head fins (***)				x		
Change Pump Oil (*)					x	
Replace Air Filter					x	
Check Engine Spark Plug (gasoline engines only)					x	
Add fuel stabilizer						x
Run unit dry						x

- The pump oil must be changed after the first 50 hours of operation and every 200 hours or 3 months, whichever comes first.
 - The engine oil must be changed after the first 5 hours of operation and every 50 hours or 3 months, whichever comes first.
 - Service more frequently under dusty conditions.
- Every 2 years, an Authorized Mi-T-M Service Technician should check the safety valve, intake valves and delivery valves.

MAINTENANCE

ENGINE:

The engine for this unit is governed to operate at speeds close to 3600 RPM (60Hz) throughout the operating load range.



WARNING: DO NOT TAMPER WITH THE GOVERNOR MECHANISM, CHANGE THE SETTING EXPERIMENTALLY, OR PUSH THE THROTTLE OPEN IN AN ATTEMPT TO GENERATE MORE ELECTRICAL CURRENT; EQUIPMENT DAMAGE OR PERSONAL INJURY MAY RESULT.

GOVERNOR SPEED ADJUSTMENT SHOULD BE MADE ONLY BY A JOHN DEERE SERVICING DEALER.

CHECKING ENGINE OIL:

Check oil level before each operation and ensure that it is maintained per engine manual.

CHANGING ENGINE OIL:

Change oil after the first 25 hours of operation. Thereafter it should be changed every 50 hours.

1. Make sure the unit is on level ground. Run the engine to warm the oil.
2. Stop the engine.
3. Remove the oil drain plug. (See Fig. 1)

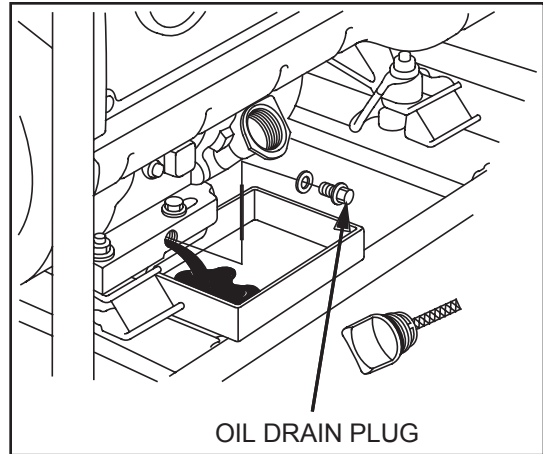

(Fig. 1)



CAUTION: OIL BEING DRAINED MAY BE HOT. TO REDUCE THE RISK OF BURN INJURY, HANDLE WITH CARE. DISPOSE OF USED OIL PROPERLY.

4. Drain oil while engine is warm, into a suitable container.
5. Reinstall the oil drain plug.
6. Remove oil gauge and refill with new oil. (Fig. 2)
7. Check the oil level as instructed in the engine manual.
8. Wipe up any spilled oil.

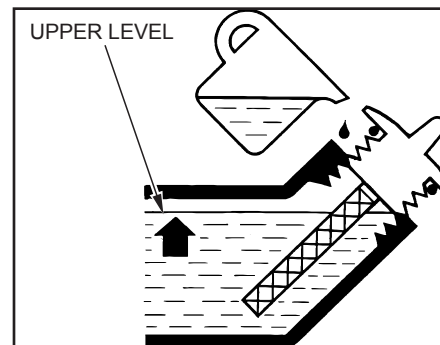

(Fig. 2)

MAINTENANCE

AIR CLEANER:



WARNING: RISK OF FIRE OR EXPLOSION. DO NOT USE GASOLINE OR LOW FLASH-POINT SOLVENTS TO CLEAN THE ELEMENT. CLEAN THE ELEMENT IN A WELL VENTILATED AREA. ENSURE THAT NO SPARKS OR FLAMES ARE NEAR THE WORKING AREA, THIS INCLUDES ANY APPLIANCE WITH A PILOT LIGHT.



CAUTION: NEVER RUN THE ENGINE WITHOUT THE AIR FILTER, SERIOUS DANGER CAN RESULT.

Check the air cleaner daily or before starting the engine. Check for and correct heavy buildup of dirt and debris along with loose or damaged components.

1. Unscrew the air cleaner cover and remove the elements.
2. Clean the element:

PAPER AIR CLEANER ELEMENT: Do not wash the paper element or use pressurized air, as this will damage the element. Clean by gently tapping the element to remove dust. Replace the element if damaged, bent or extremely dirty. Handle new element carefully; do not use if the sealing surfaces are bent or damaged.

NOTE: *Replace the paper element every 100 hours (more often under extremely dusty conditions.)*

3. Reinstall the paper air cleaner element. Close air cleaner cover and screw shut.

MAINTENANCE

CLEANING AND GAPPING SPARK PLUG (GASOLINE ENGINES ONLY):

If the plug is contaminated with carbon, remove it using a plug cleaner or wire brush.

Check the spark plug gap and reset it if necessary. The spark plug gaps are listed below. To change the gap, bend the side-electrode only, using a spark plug tool. (Fig. 3)

Install and tighten the spark plug. Connect the spark plug lead.

Recommended Spark Plug:

Engine	Honda
Spark Plug	NGK BPR6ES
Spark Plug Gap	0.7 - 0.8 mm (0.03 in.)
Torque - New	8.7-10.9 ft-lb
Torque - Retighten	16.6-19.5 ft-lb

BELT TENSION ADJUSTMENT:

To maintain peak performance of your unit, it may be necessary to adjust the belt tension on occasion. Follow the procedure outlined below:

1. Remove the beltguard and loosen the two nuts on each side of the pump or engine. There are a total of 4 nuts.
2. Turn the cap screw clockwise until a 1/2 inch belt deflection is noticed between the pulleys.
3. Tighten the side nuts.
4. Put a straight edge across both pulleys. If necessary, loosen one set of pulley screws and adjust in or out to properly align. Tighten the pulley screws and check the tension again.
5. Replace the beltguard and tighten the fasteners securely.

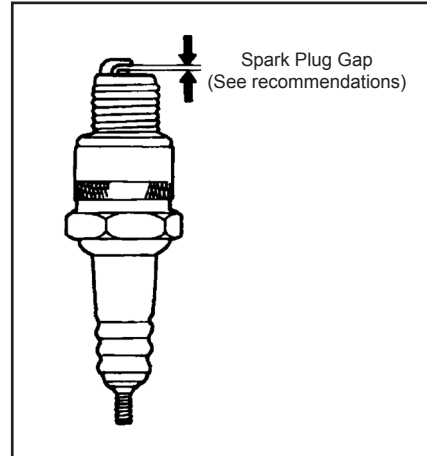

(Fig. 3)

Storage

STORING UNIT

SHORT TERM (1-6 months):

1. Add fuel conditioner & stabilizer at the specified concentration.
2. Run the unit for two (2) minutes to ensure the mixed fuel is in the entire fuel system. Close the fuel valve and run the unit until it stops.
3. For Gasoline Engines: Remove the spark plug, pour 1-2 teaspoons (5-10cc) of engine oil into the cylinder, slowly pull the starter handle 2 or 3 times, reinstall the spark plug and tighten securely.
4. Clean the exterior surface of the unit and apply a rust inhibitor.
5. Store the unit in a dry, well ventilated place.

LONG TERM (More than 6 months):

1. Add fuel conditioner & stabilizer at the specified concentration.
2. Run the unit until the fuel tank and carburetor are dry. As the engine is beginning to die, move the choke lever to the choke position.

NOTE: Turn off the idle control to decrease the run time.

3. For Gasoline Engines: Remove the spark plug, pour 1-2 teaspoons (5-10cc) of engine oil into the cylinder, slowly pull the starter handle 2 or 3 times, reinstall the spark plug and tighten securely.
4. Clean the exterior surface of the unit and apply a rust inhibitor.
5. Store the unit in a dry, well ventilated place.



WARNING: FUEL SHOULD BE DRAINED IN A WELL VENTILATED AREA AND STORED IN AN APPROVED CONTAINER.

Specifications

ITEM	SPECIFICATION			
Unit	*AG2-PH13-08M1 *AG2-SH13-08M1 **AG2-SH13-30M ***AG2-SH13-B	*AG2-PK14-08M1 *AG2-SK14-08M1 **AG2-SK14-30M ***AG2-SK14-B	*AG2-PM14-08M1 *AG2-SM14-08M1 **AG2-SM14-30M ***AG2-SM14-B	*AG2-PV14-08M1 *AG2-SV14-08M1 **AG2-SV14-30M ***AG2-SV14-B
Engine	Honda	Kohler	Mi-T-M	Vanguard
HP	13	14	14	14
Oil (oz)	37 oz	44 oz	32 oz	32 oz
Watts w/o Comp	3500			
Watts w/ Comp	3000			
Rated Voltage (V)	120V			
Frequency (Hz)	60 Hz			
Comp Pump	2 stage			
Pump Oil (oz)	24.7			
Air Tank (gal)	*8 gallon **30 gallon ***N/A			
Max Pressure (psi)	175 psi			

ITEM	SPECIFICATION	
Unit	AG1-PH65-08M1	AG2-SKD9-30M
Engine	Honda	Kohler
HP	6.5	9.1
Oil (oz)	20 oz	48 oz.
Watts w/o Comp	1600	2750
Watts w/ Comp	600	1800
Rated Voltage (V)	120V	
Frequency (Hz)	60 Hz	
Comp Pump	1 stage	2 Stage
Pump Oil (oz)	25.3	24.7
Air Tank (gal)	8 gallon	30 gallon
Max Pressure (psi)	125 psi	175 psi

RECORD SERIAL NUMBER

Write you model number, machine serial number and date of purchase in the spaces provided below. Your dealer needs this information when ordering parts.

Model No. _____

Machine Serial No. _____

Date of Purchase _____

(To be filled in by purchaser)



STATEMENT OF WARRANTY

Mi-T-M warrants all parts, (except those referred to below), of your new unit to be free from defects in materials and workmanship during the following periods:

For Two (2) years from the date of original purchase:

Compressor Pump	Plumbing
Generator	Tank Assembly

For Six (6) months from date of original purchase:

Pressure Switch	Regulator
Check Valve	Pilot Valve
Copper/stainless steel line	

For Ninety (90) days from the date of original purchase:

Pressure Gauges	Safety Relief Valves
Drain Valves	

Defective parts not subject to normal wear and tear will be repaired or replaced at our option during the warranty period. In any event, reimbursement is limited to the purchase price paid.

EXCLUSIONS

1. Engine is covered under separate warranty by its respective manufacturer and is subject to the terms set forth therein.
2. Normal wear parts:

Isolators	Air Filter
-----------	------------
3. This warranty does not cover parts damaged due to normal wear, abnormal conditions, misapplication, misuse, accidents, operation at other than recommended speeds, pressures or temperature, improper storage or freight damage. Parts damaged or worn by operation in dusty environments are not warranted. Failure to follow recommended operating and maintenance procedures also voids warranty.
4. Labor charges, loss or damage resulting from improper operation, maintenance (other than routine air tank draining and oil changes, if applicable) or repairs made by persons other than a Mi-T-M Authorized Service Center.
5. The use of other than Genuine Mi-T-M Repair Parts will void warranty. Parts returned, prepaid to our factory or to an Mi-T-M Authorized Service Center will be inspected and replaced free of charge if found to be defective and subject to warranty. Under no circumstances shall the manufacturer bear any responsibility for loss of use of the unit, loss of time or rental, inconvenience, commercial loss or consequential damages. There are no warranties which extend beyond the description of the face hereof.

For Service or Warranty Consideration, contact
Mi-T-M[®] Corporation, 50 Mi-T-M Drive, Peosta, IA 52068
563-556-7484 / 800-553-9053 / Fax 563-556-1235
Monday - Friday 8:00 a.m. - 5:00 p.m. CST